

4-WAY TOGGLE VALVES



4-WAY TOGGLE VALVES

4-way valves can supply and exhaust two different outlets, and are commonly used with double-acting cylinders. When the toggle is in one position air flows from the inlet to one of the outlets. The second outlet is open to the exhaust port which is vented to atmosphere. Moving the toggle to the opposite position opens the inlet to the second outlet

while exhausting the first outlet. 4-way toggle valves are spool valves that by movement of the toggle may either be 2-position or have a momentary actuation.

Medium: Air

Stem Travel: 1/8" (3.2)

Materials: Brass body, Buna-N seals, stainless steel stem and spring

Mounting: 15/32-32 thread. Nuts and lockwashers furnished.

2 Position Spool Valves

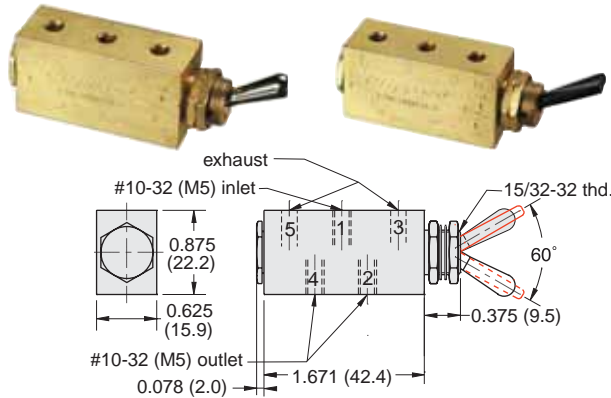

Input Pressure: 150 psig/10 bar max.

Air Flow: 6 SCFM @ 50 psig; 10 SCFM @ 100 psig;
240 l/min @ 6 bar

Force For Full Stem Travel: 12 oz. nominal

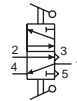

Part No.	Description
MTV-4	.2 Position Spool Valve, NP Brass Toggle, #10-32
MTV-4-M5	.2 Position Spool Valve, NP Brass Toggle, M5
MTV-4F	.2 Position Spool Valve, Plastic Toggle, #10-32
MTV-4F-M5	.2 Position Spool Valve, Plastic Toggle, M5

J-Series 2 Position Spool Valves

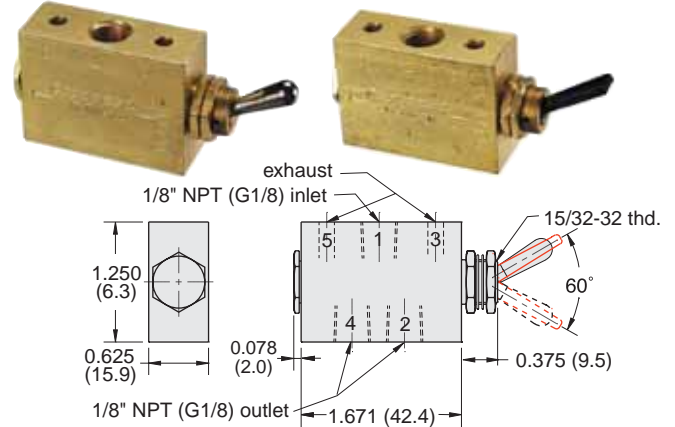

Input Pressure: 150 psig/10 bar max.

Air Flow: 6.5 SCFM @ 50 psig; 10.5 SCFM @ 100 psig;
250 l/min @ 6 bar

Force For Full Stem Travel: 12 oz. nominal

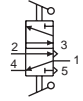

Part No.	Description
MJTV-4	.2 Position Spool Valve, NP Brass Toggle, 1/8" NPT
MJTV-4-MG	.2 Position Spool Valve, NP Brass Toggle, G1/8
MJTV-4F	.2 Position Spool Valve, Plastic Toggle, 1/8" NPT
MJTV-4F-MG	.2 Position Spool Valve, Plastic Toggle, G1/8

2 Position Fully-Ported Spool Valves

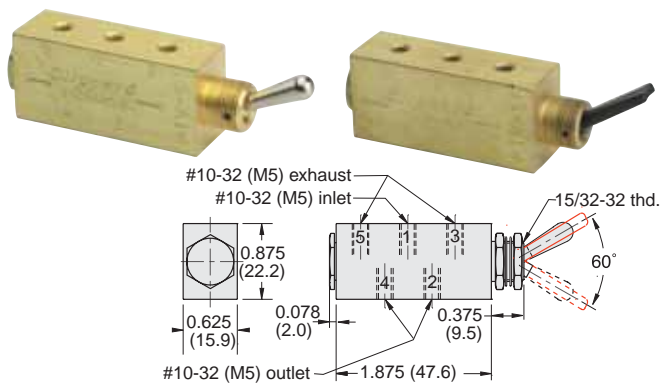

Input Pressure: 150 psig/10 bar max.

Air Flow: 6 SCFM @ 50 psig; 10 SCFM @ 100 psig;
240 l/min @ 6 bar

Force For Full Stem Travel: 16 oz. nominal

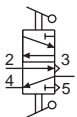

Part No.	Description
MTV-5	.2 Position Spool Valve, NP Brass Toggle, #10-32
MTV-5-M5	.2 Position Spool Valve, NP Brass Toggle, M5
MTV-5F	.2 Position Spool Valve, Plastic Toggle, #10-32
MTV-5F-M5	.2 Position Spool Valve, Plastic Toggle, M5

J-Series 2 Position Fully-Ported Spool

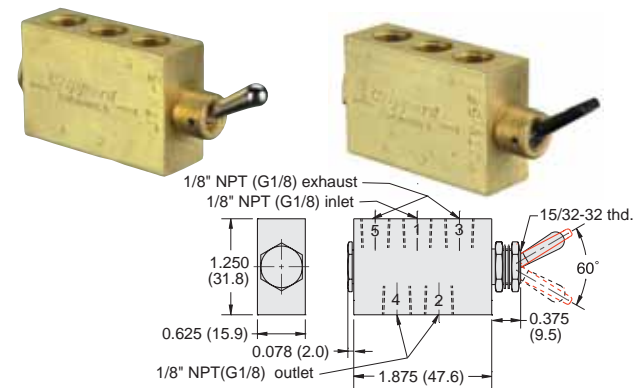

Input Pressure: 150 psig/10 bar max.

Air Flow: 6.5 SCFM @ 50 psig; 10.5 SCFM @ 100 psig;
250 l/min @ 6 bar

Force For Full Stem Travel: 16 oz. nominal

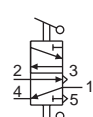

Part No.	Description
MJTV-5	.2 Position Spool Valve, NP Brass Toggle, 1/8" NPT
MJTV-5-MG	.2 Position Spool Valve, NP Brass Toggle, G1/8
MJTV-5F	.2 Position Spool Valve, Plastic Toggle, 1/8" NPT
MJTV-5F-MG	.2 Position Spool Valve, Plastic Toggle, G1/8